

1. Hallar la intersección entre los planos  $\alpha$  y  $\beta$  en los siguientes casos:

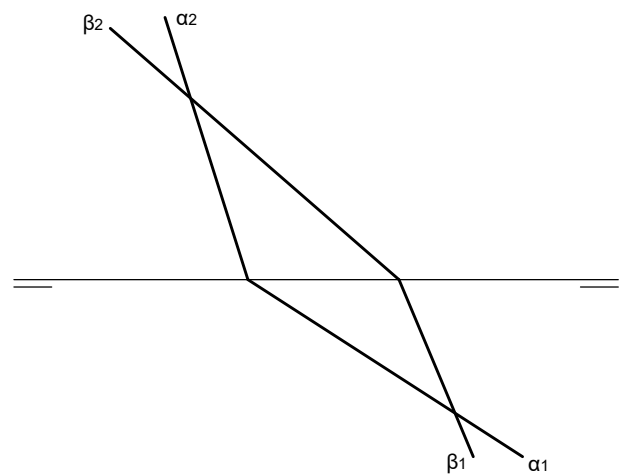

1. Hallar la intersección entre los planos  $\alpha$  y  $\beta$  en los siguientes casos:

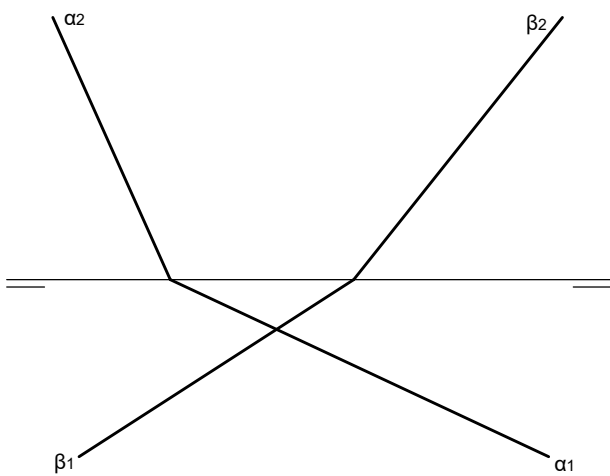
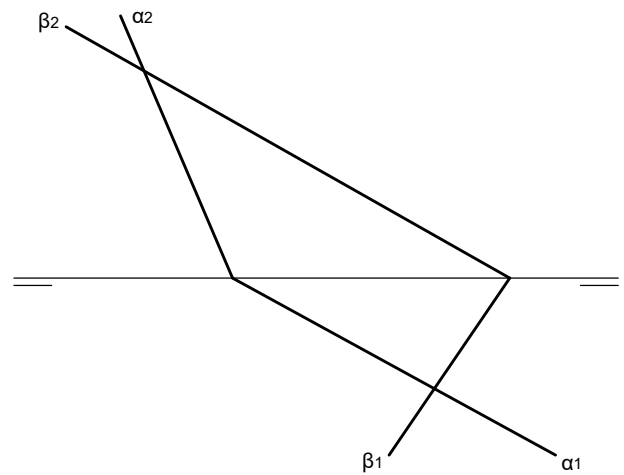
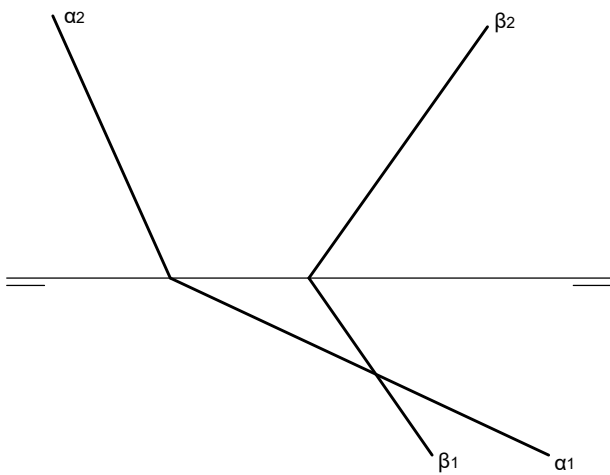
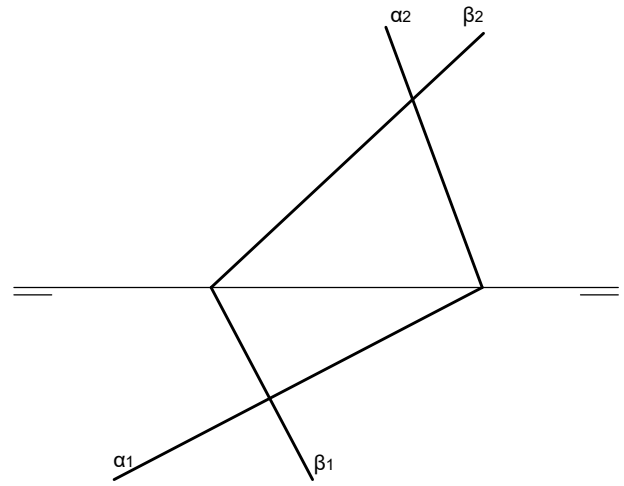
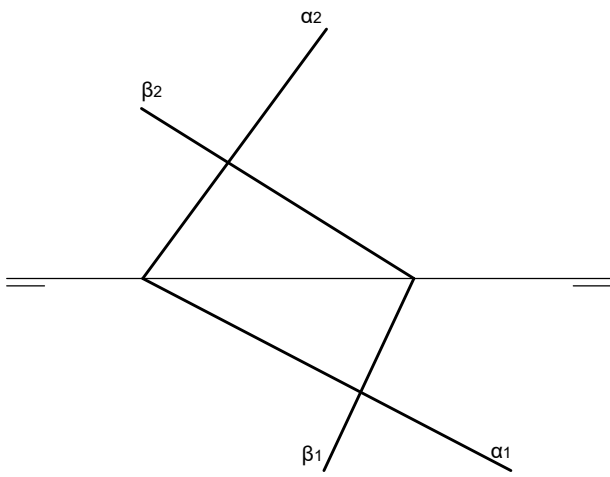
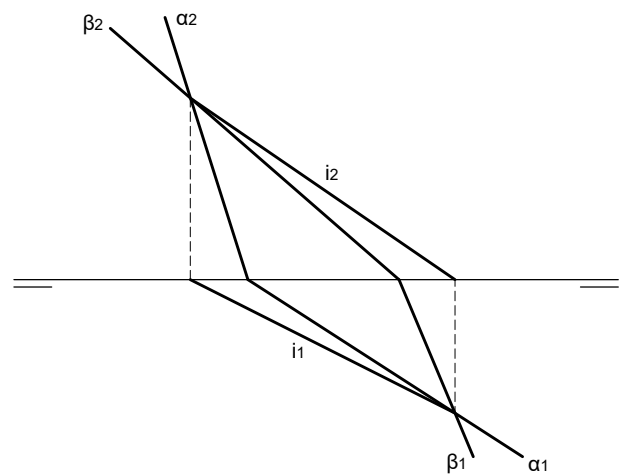
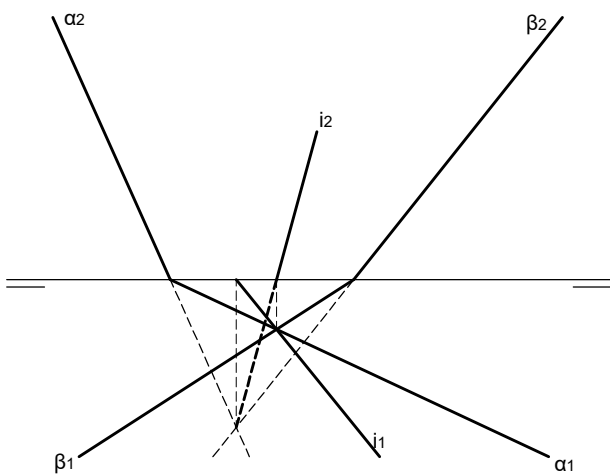
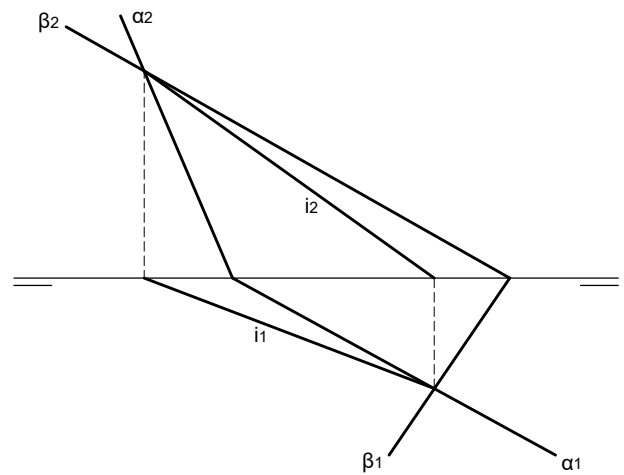
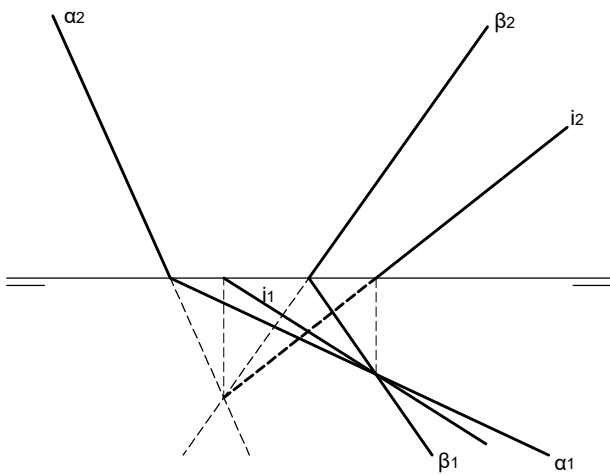
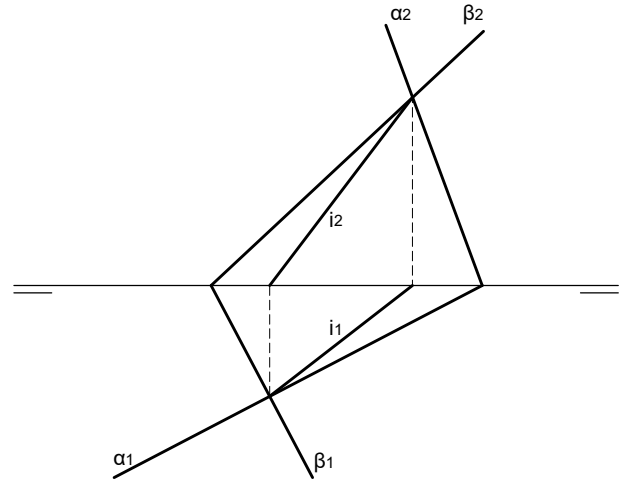
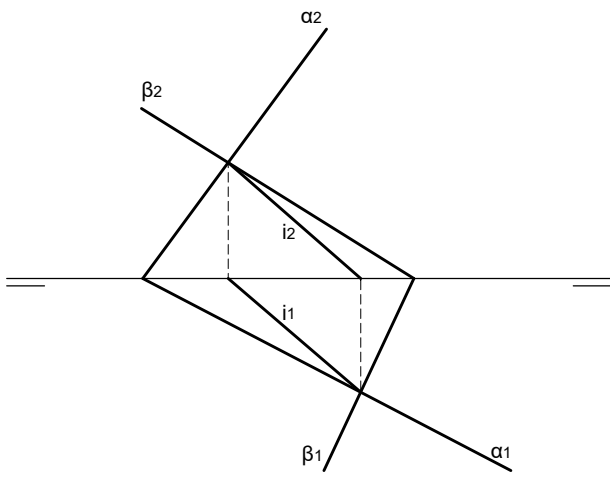

1. Hallar la intersección entre los planos  $\alpha$  y  $\beta$  en los siguientes casos:

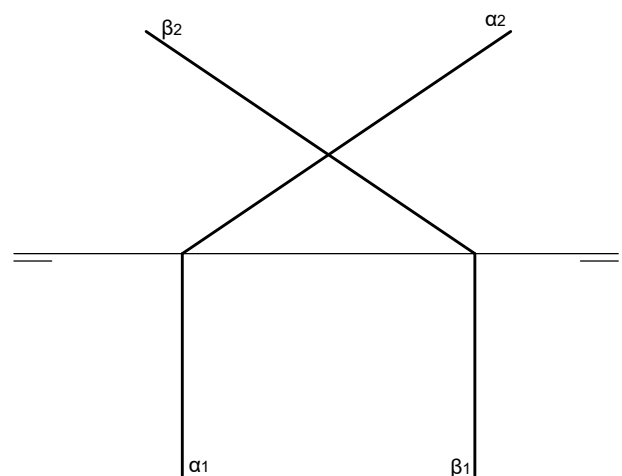
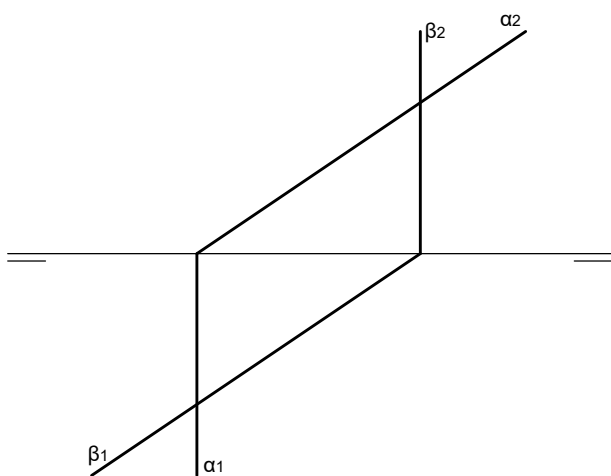
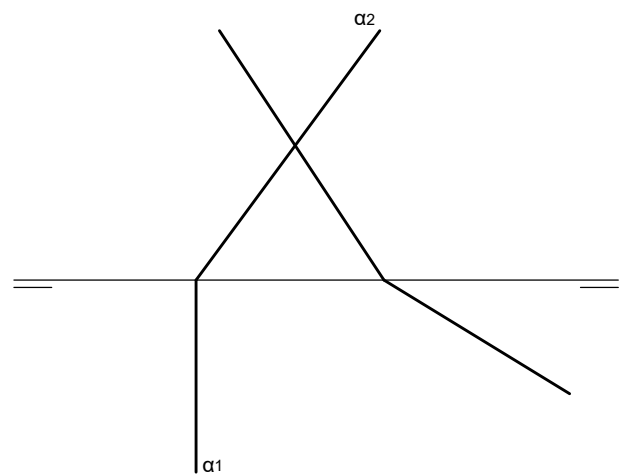
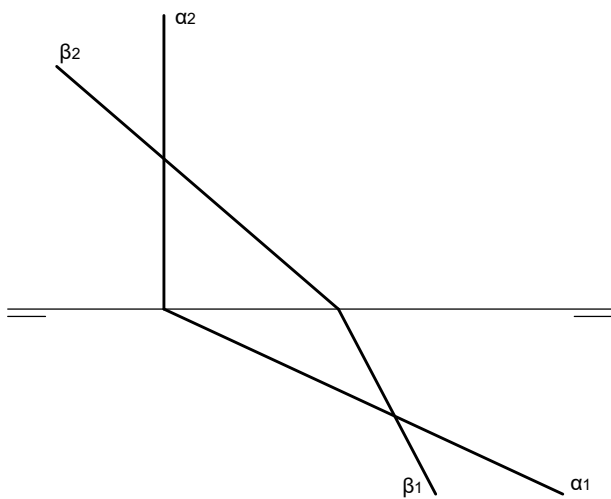
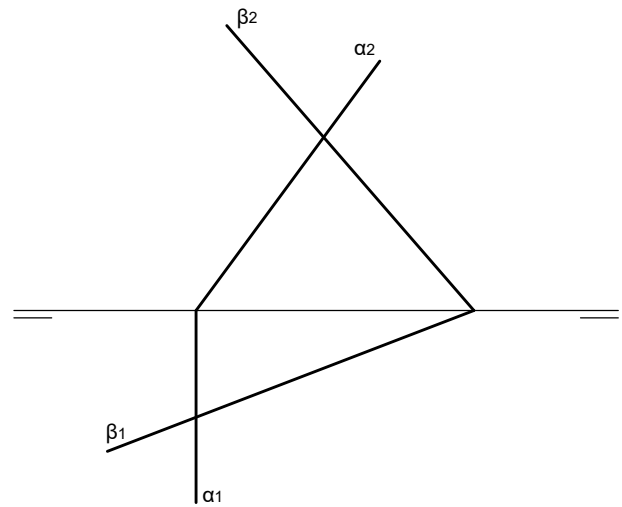
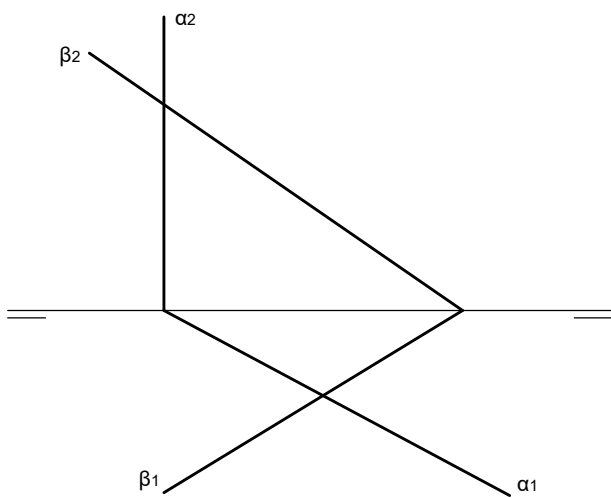

1. Hallar la intersección entre los planos  $\alpha$  y  $\beta$  en los siguientes casos:

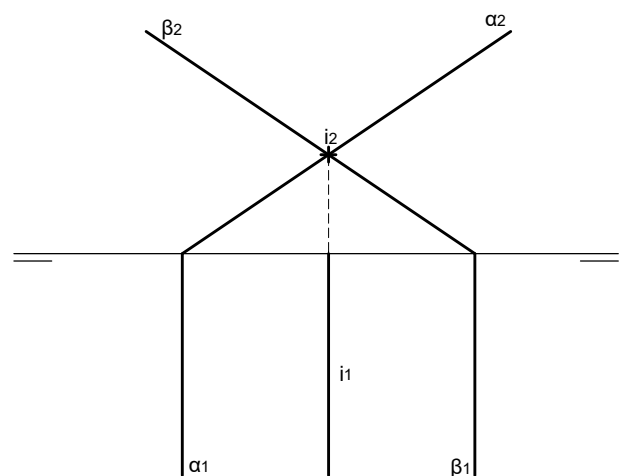
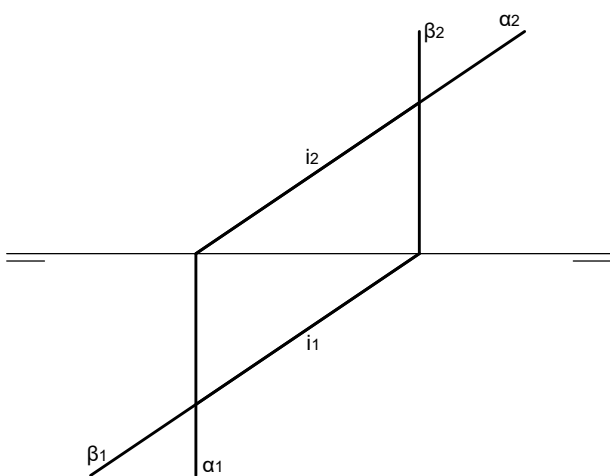
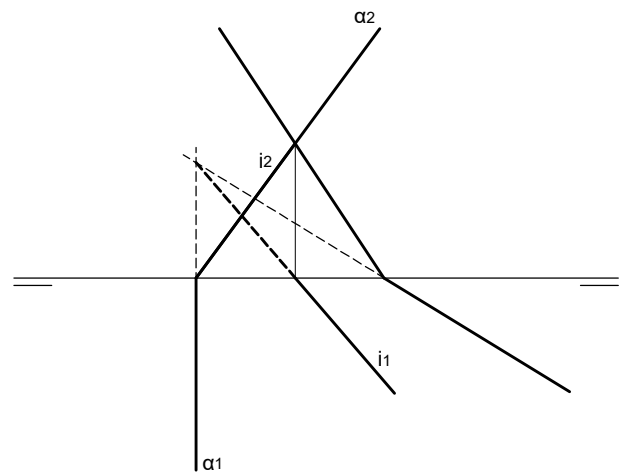
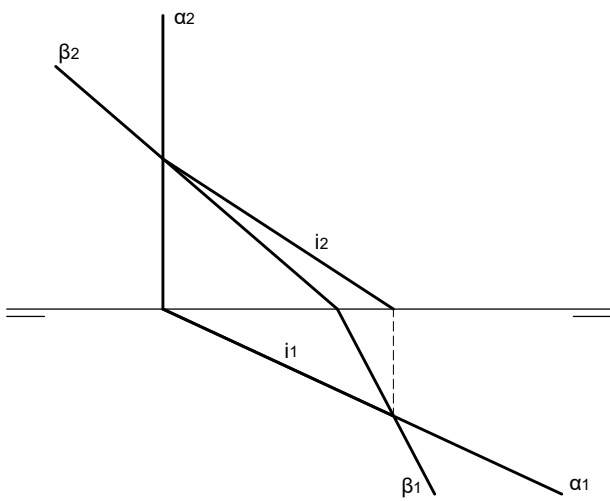
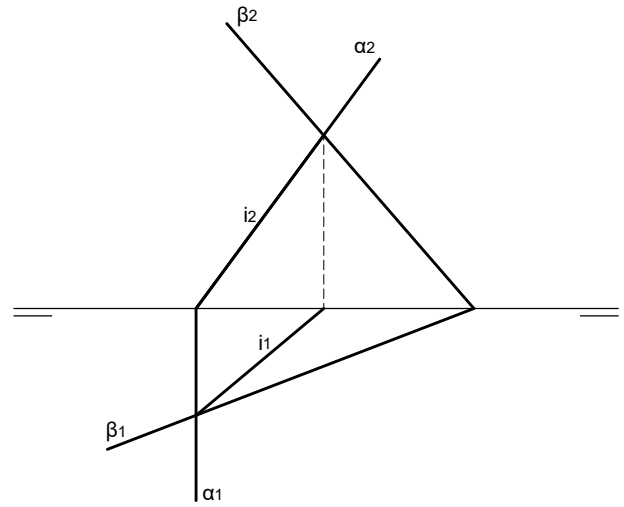
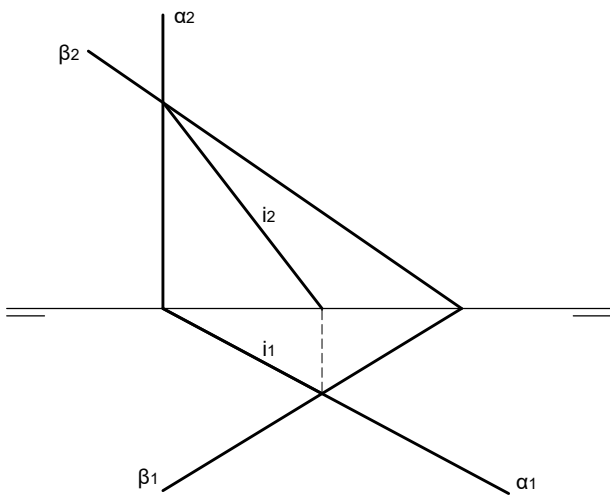

1. Hallar la intersección entre los planos  $\alpha$  y  $\beta$  en los siguientes casos:

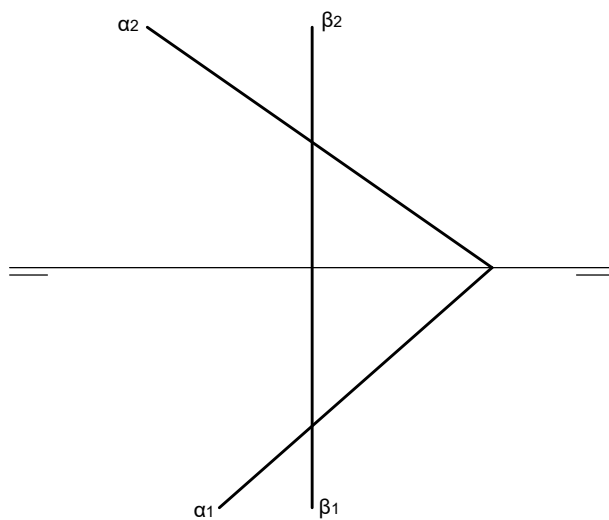
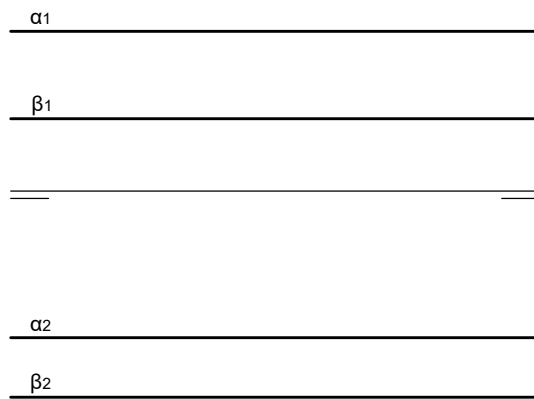
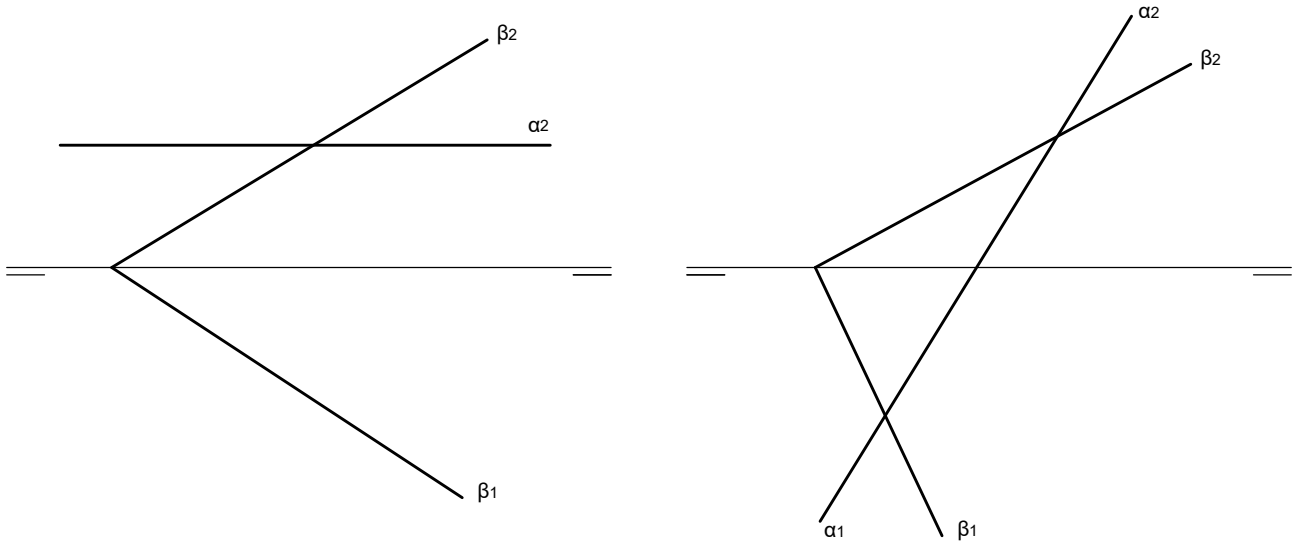

1. Hallar la intersección entre los planos  $\alpha$  y  $\beta$  en los siguientes casos:

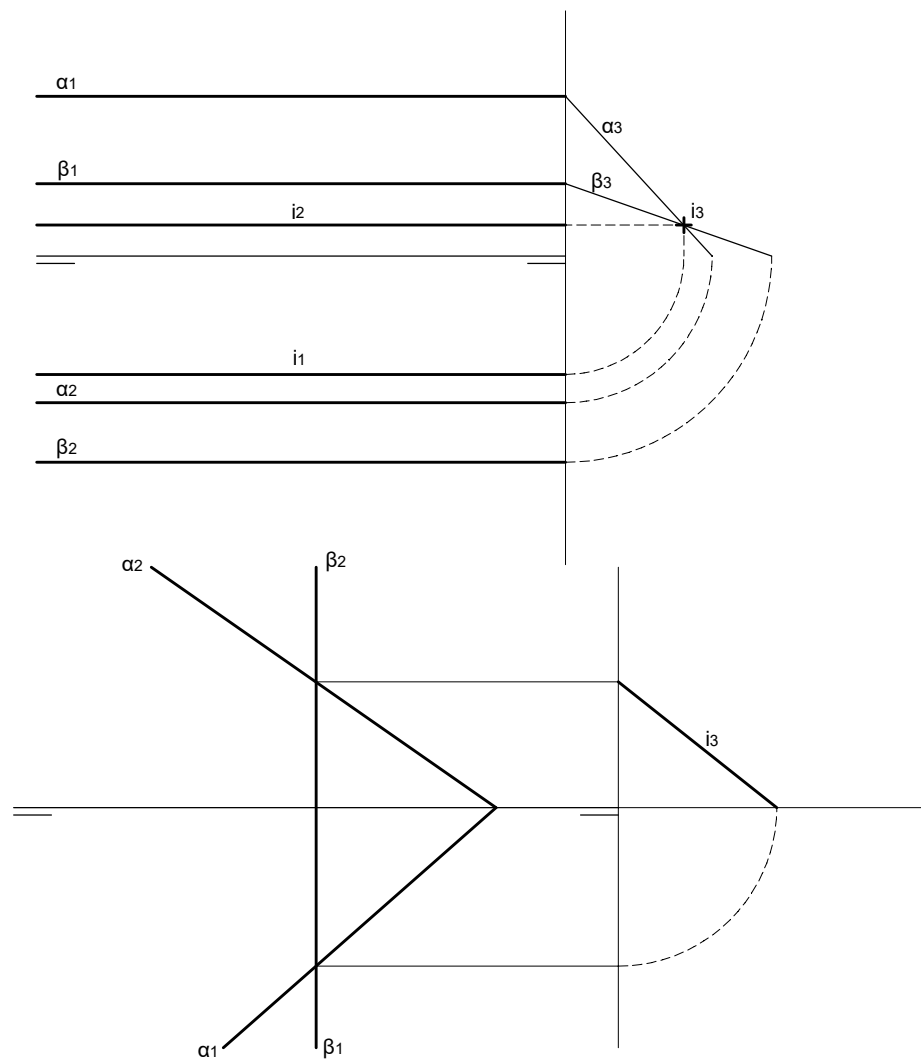
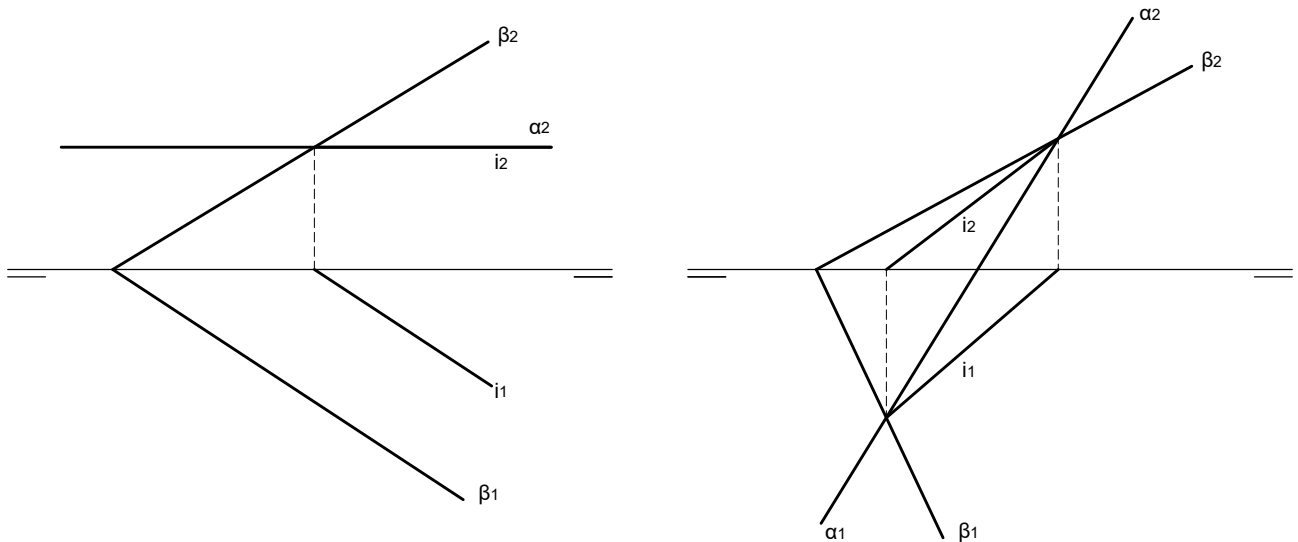

1. Trazar la recta intersección entre los planos  $\alpha$  y  $\beta$  en los siguientes casos:

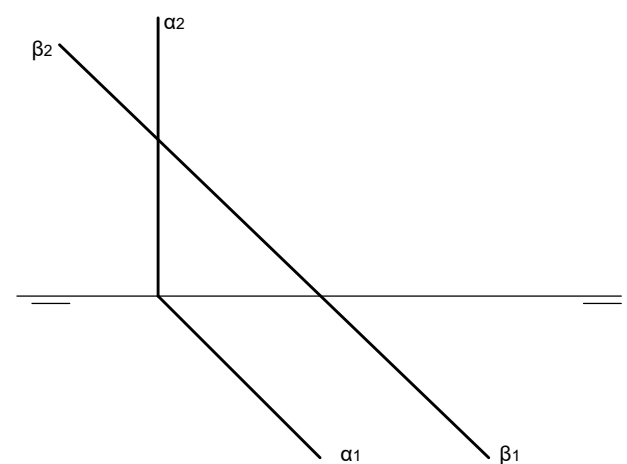
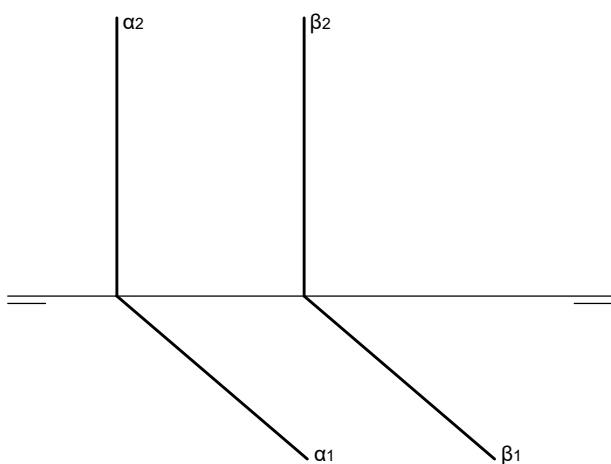
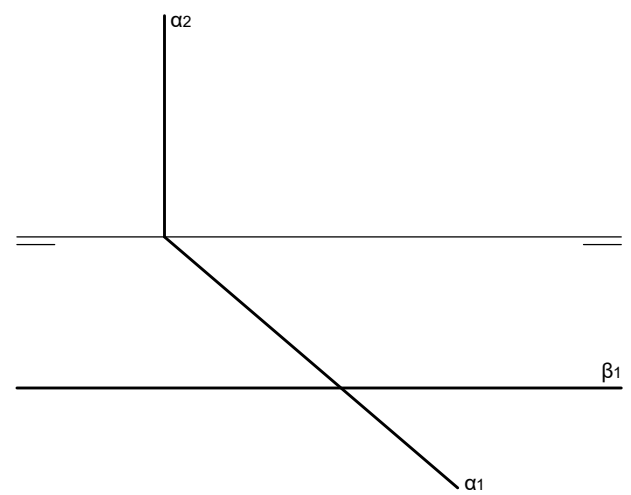
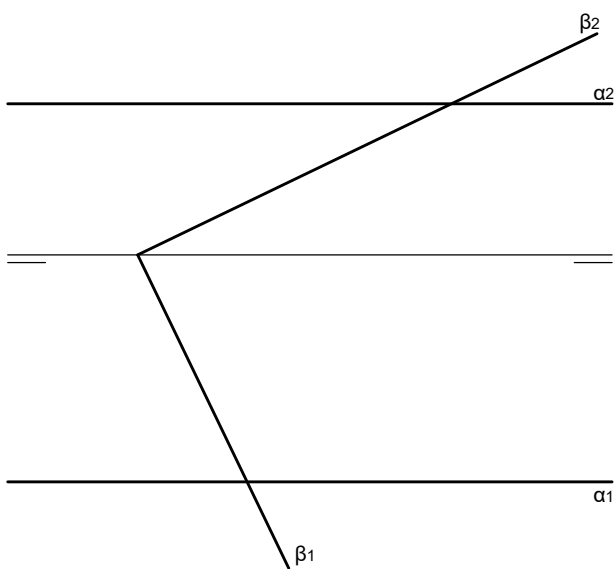
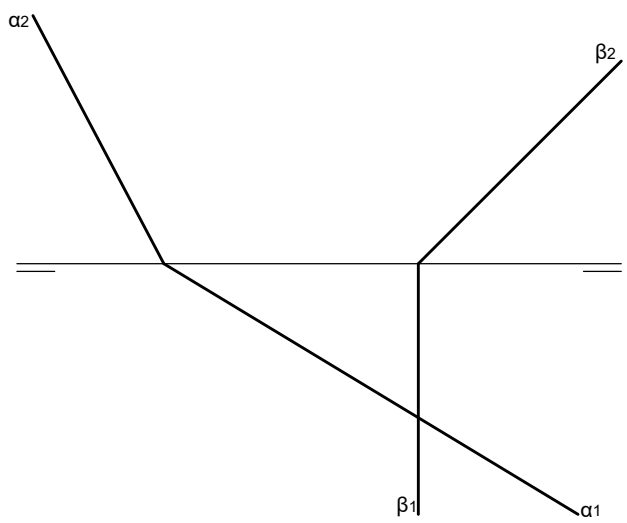
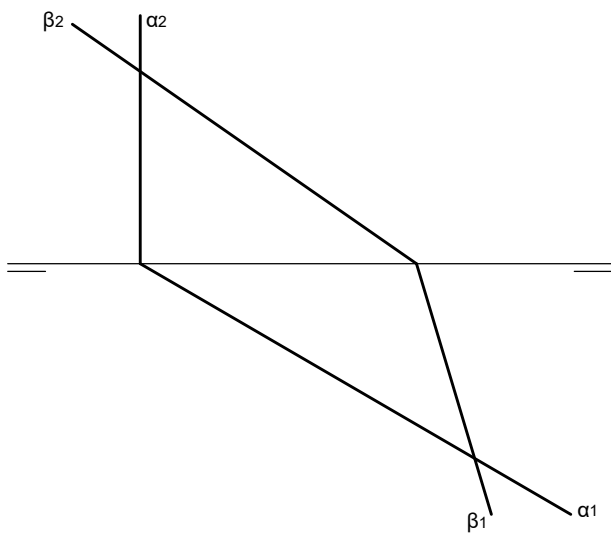

1. Trazar la recta intersección entre los planos  $\alpha$  y  $\beta$  en los siguientes casos:

