

Sistema del primer diedro / Sistema europeo

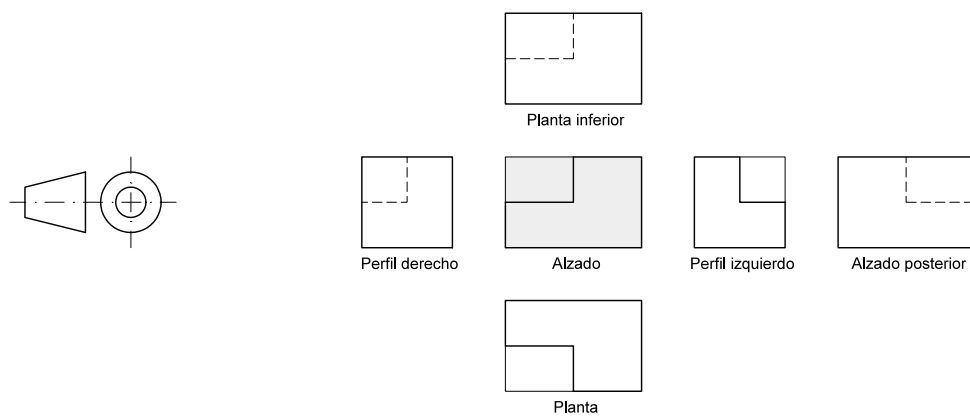

Sistema del tercer diedro / Sistema americano

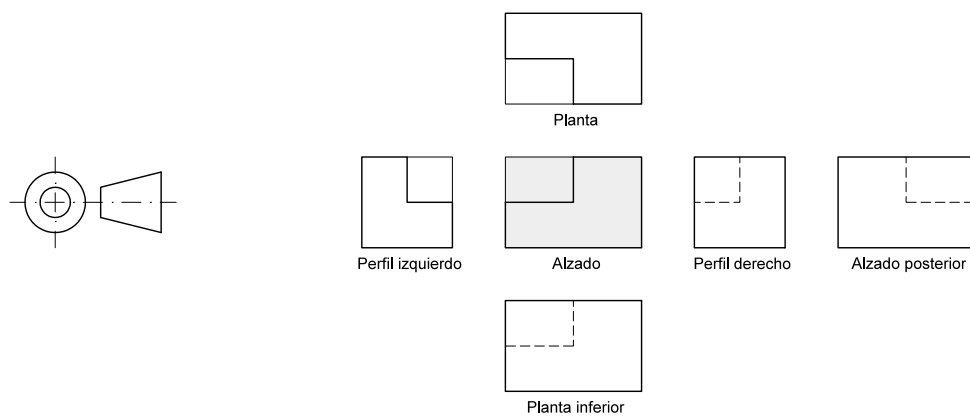

Corte total

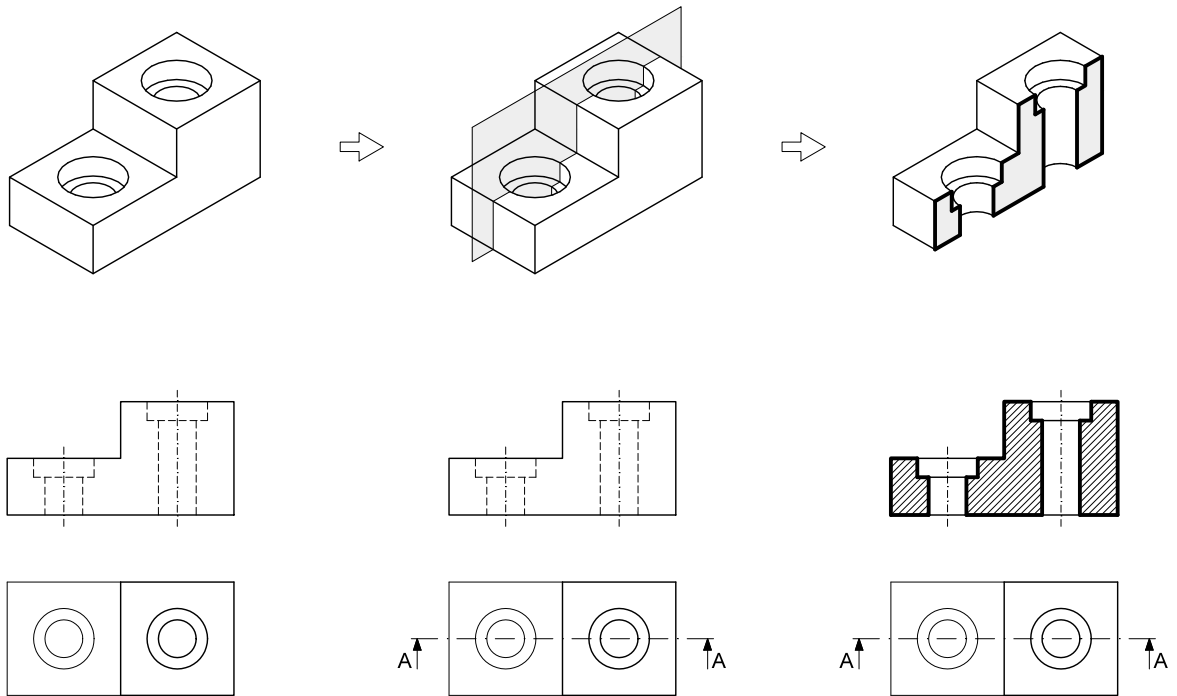

Corte por planos paralelos

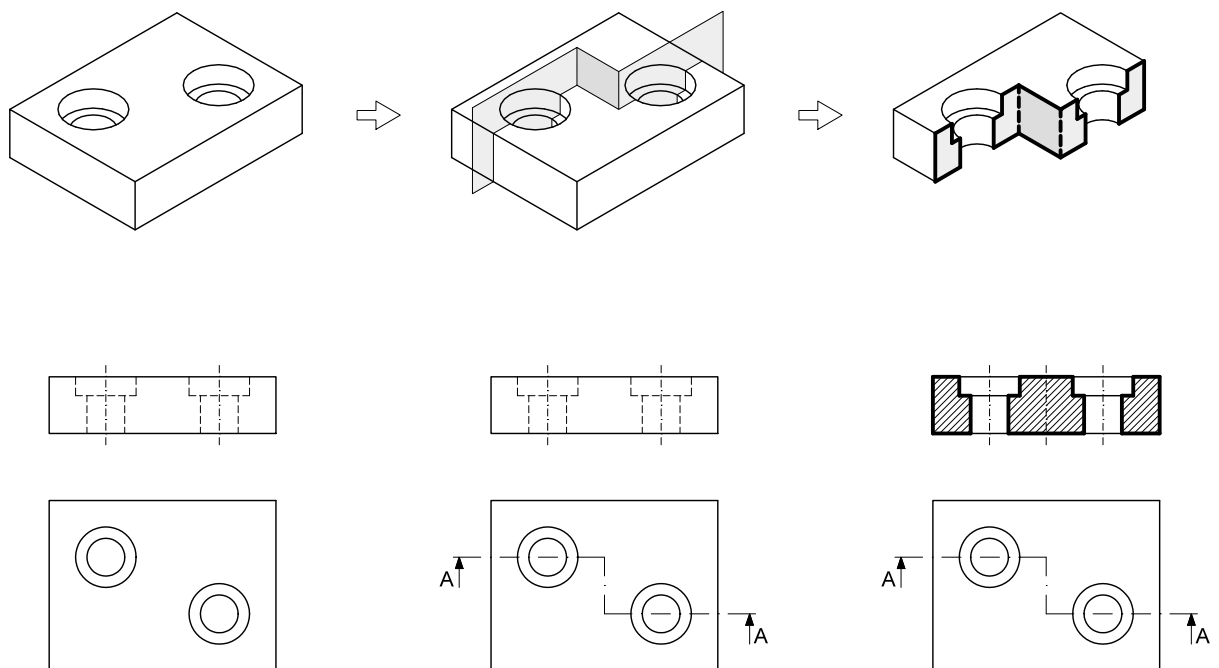

Elementos de una cota

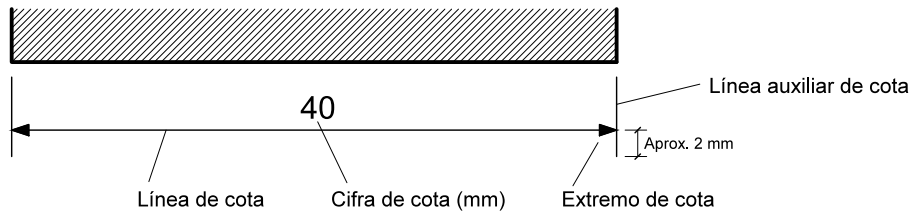

Posibles extremos de cota:

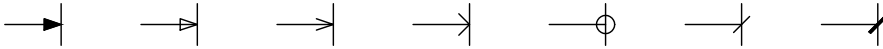

Primer método de acotación

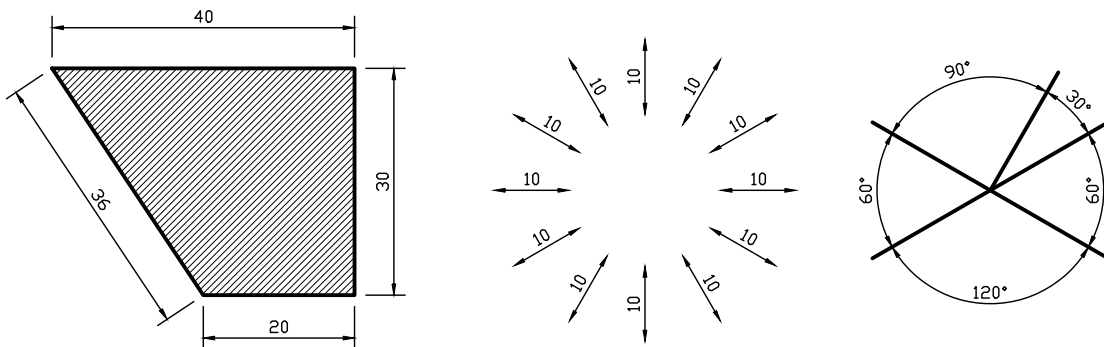

Segundo método de acotación

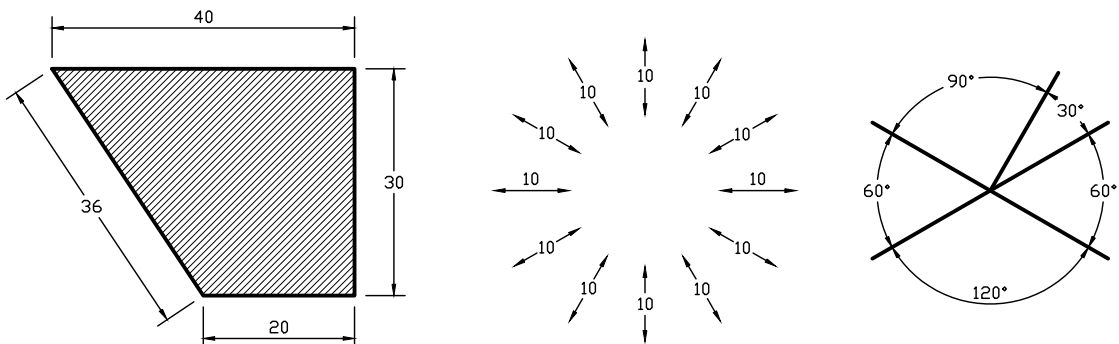

Tipos de acotación

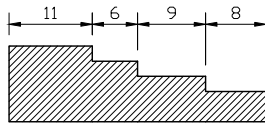

En serie

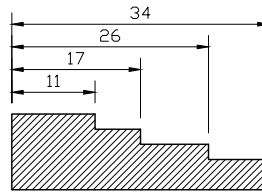

En paralelo

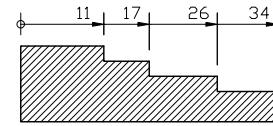

En paralelo simplificada
(a origen)

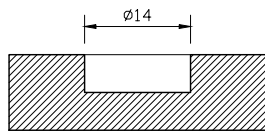

Diámetro

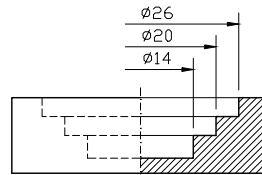

Diámetros en semicorte

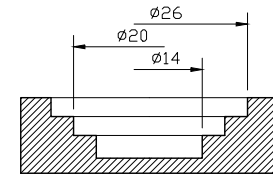

Diámetros superpuestos

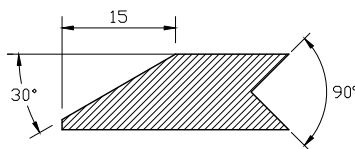

Ángulo

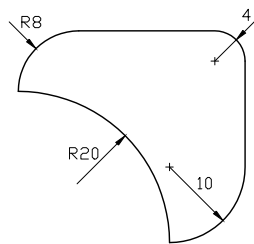

Radio

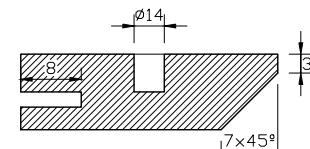

Cotas pequeñas
Cotas dentro de trama
Ángulo de 45°

Símbolos especiales

- Diámetro: ϕ
- Radio: R
- Cuadrado: \square
- Diámetro de esfera: $S\phi$
- Radio de esfera: SR

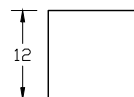
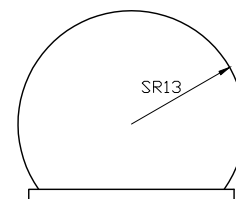
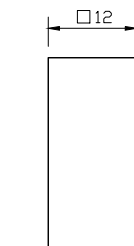

Repeticiones:

