

Elementos de la perspectiva cónica:

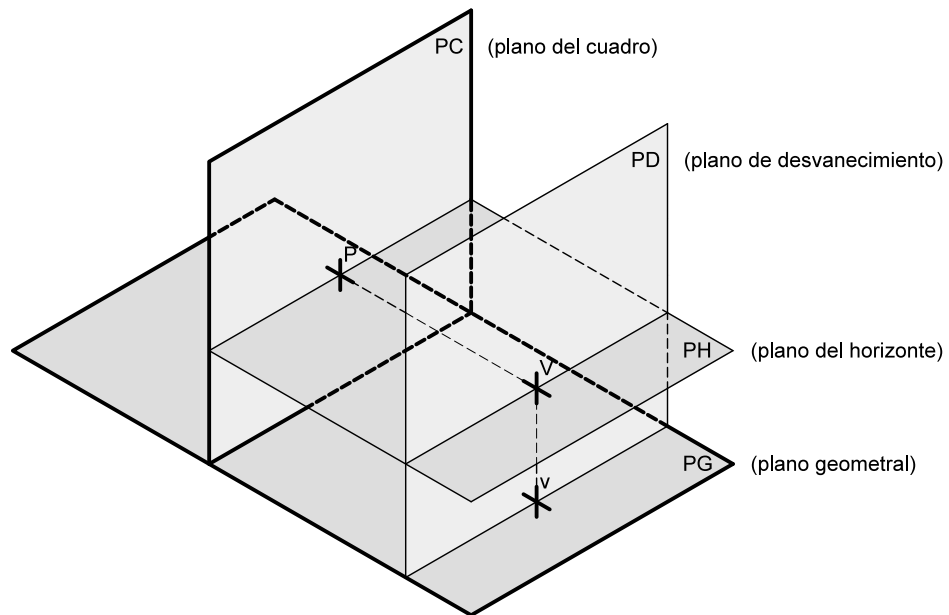

V: Centro de proyección / Punto de vista.	PC: Plano del cuadro.
P: Punto principal.	PG: Plano geometral.
v: Proyección geomtral del punto de vista.	PH: Plano del horizonte.
	PD: Plano de desvanecimiento.

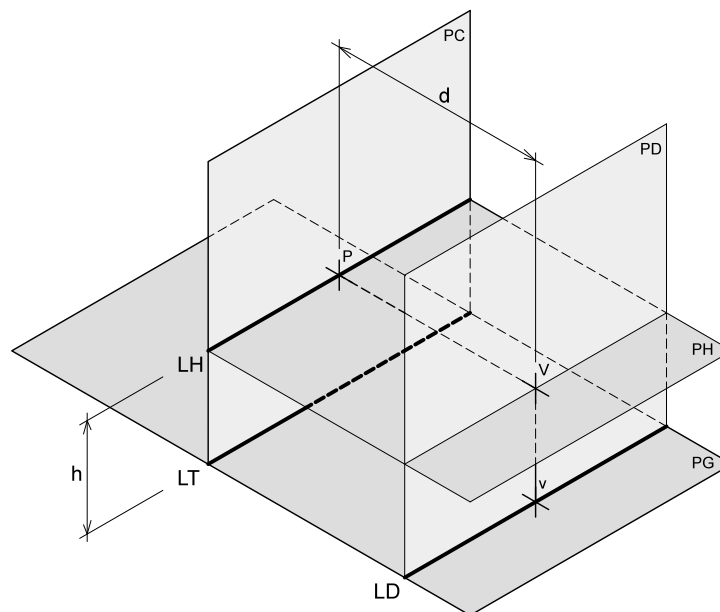

LT: Línea de tierra.	h: Altura de horizonte.
LD: Línea de desvanecimiento.	d: Distancia principal.
LH: Línea de horizonte.	

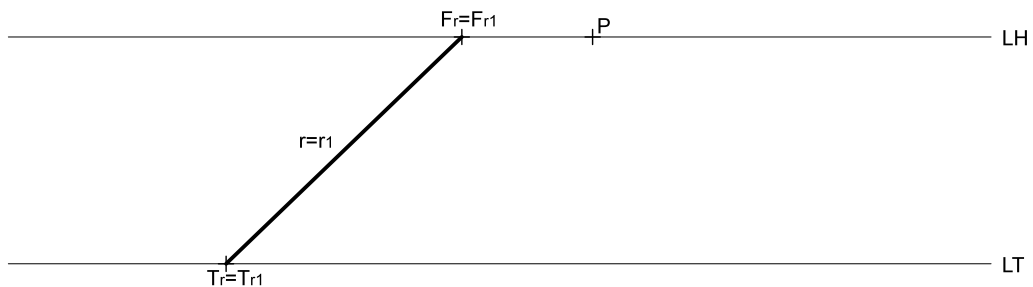
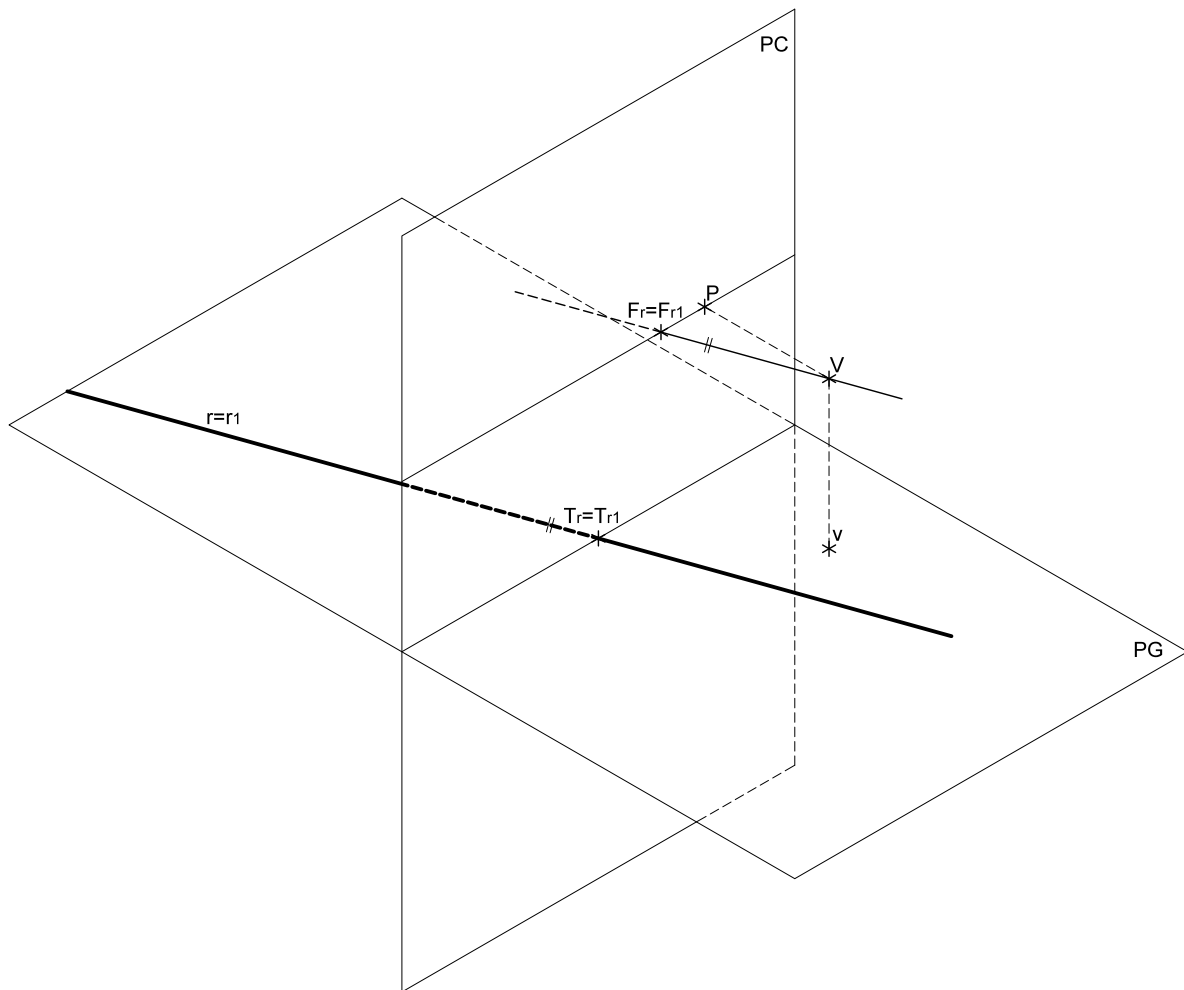

- | |
|--|
| <p>F: Punto de fuga de la recta.
 F1: Proyección del punto de fuga sobre el plano del horizonte.
 T: Traza ordinaria de la recta.
 T1: Proyección de la traza ordinaria sobre el plano geometral.
 G: Traza geometral de la recta.</p> |
|--|

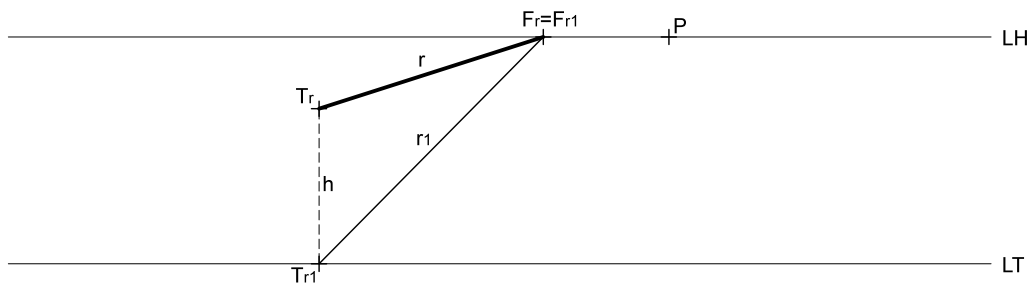
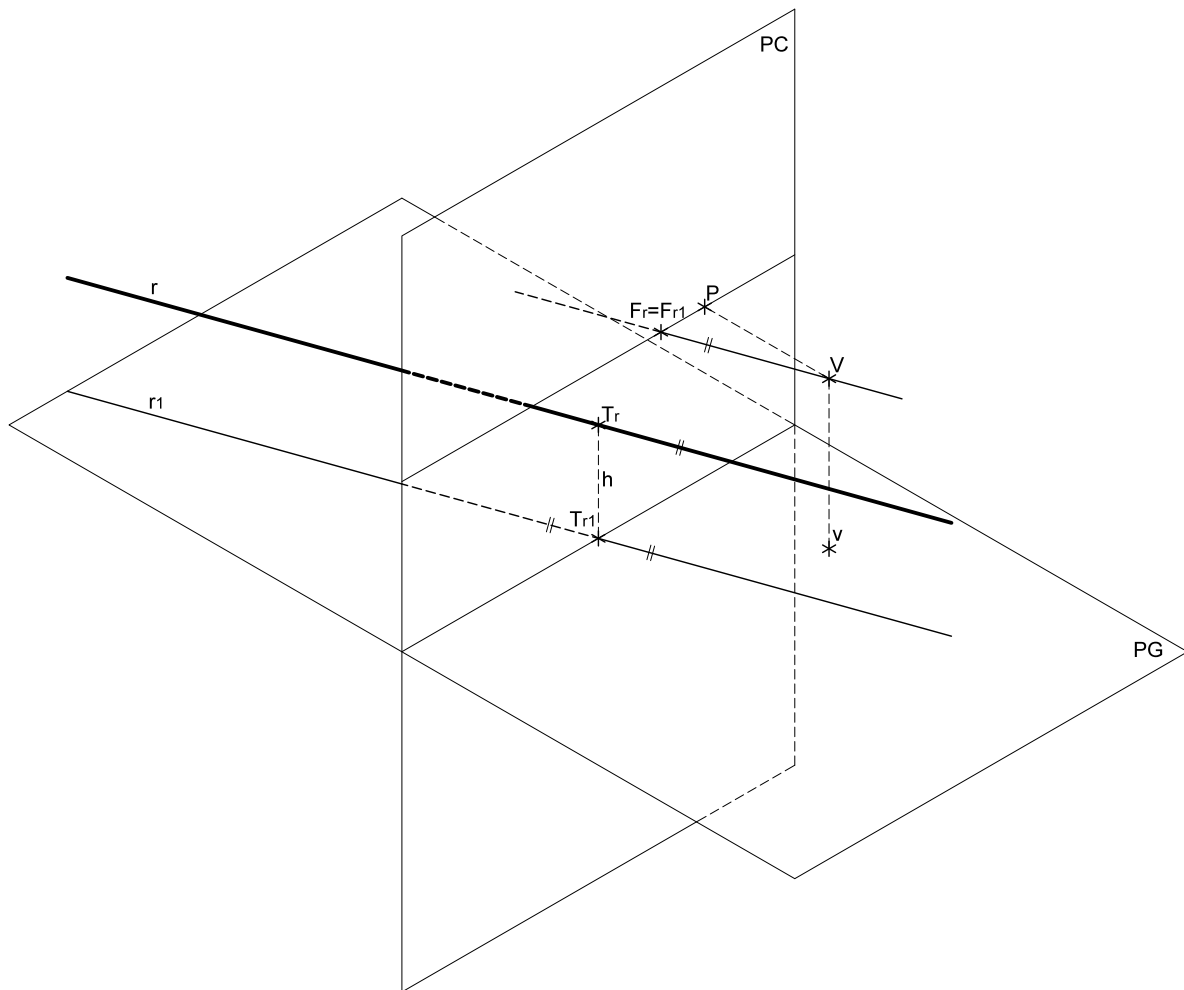

- | | |
|-----|--|
| F: | Punto de fuga de la recta. |
| F1: | Proyección del punto de fuga sobre el plano del horizonte. |
| T: | Traza ordinaria de la recta. |
| T1: | Proyección de la traza ordinaria sobre el plano geometral. |
| G: | Traza geometral de la recta. |

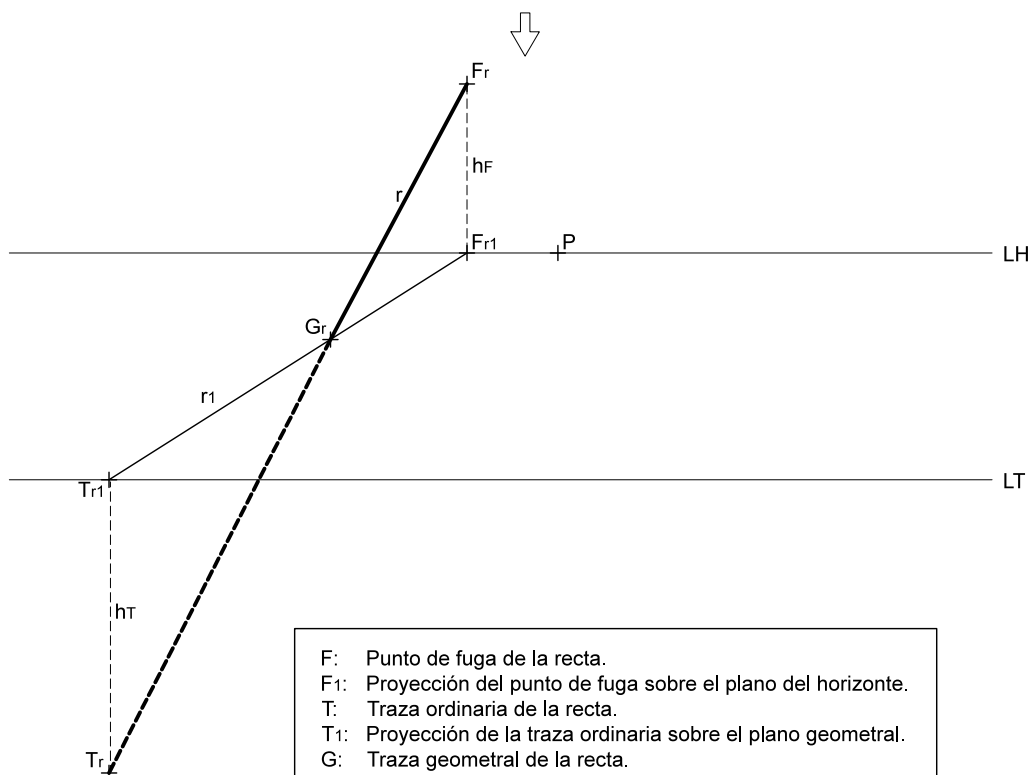
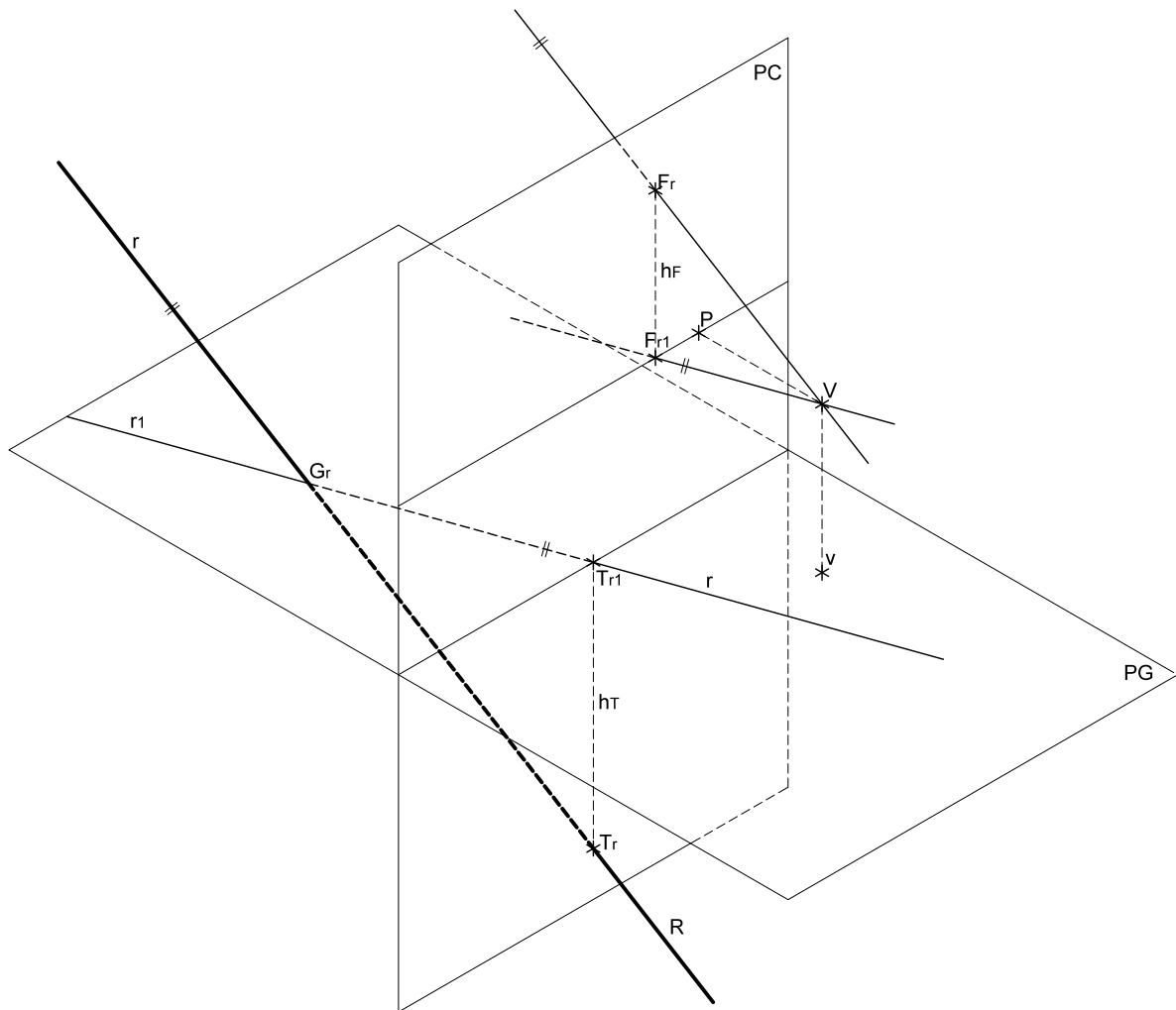

- | |
|--|
| <p>F: Punto de fuga de la recta.
 F1: Proyección del punto de fuga sobre el plano del horizonte.
 T: Traza ordinaria de la recta.
 T1: Proyección de la traza ordinaria sobre el plano geometral.
 G: Traza geometral de la recta.</p> |
|--|

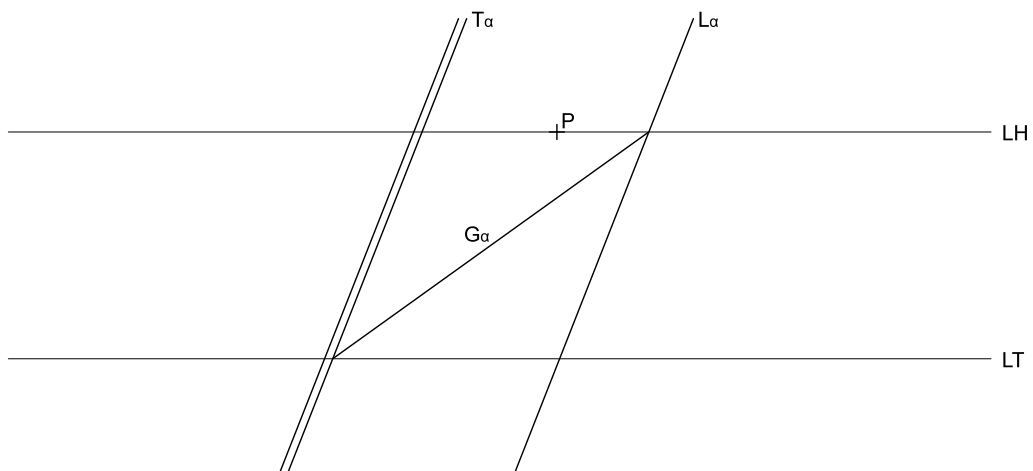
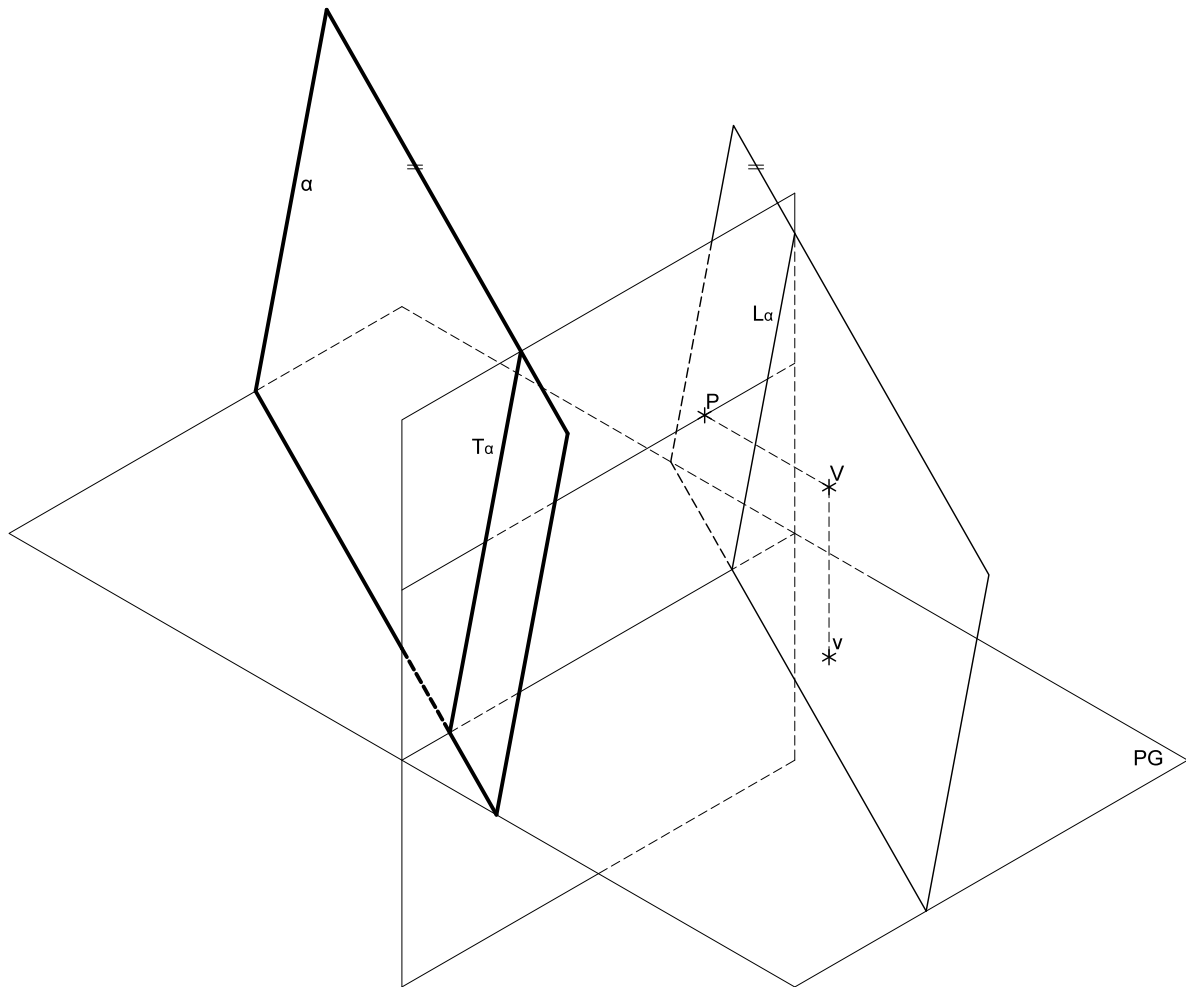

T: Traza ordinaria del plano.
L: Traza límite del plano.
G: Traza geometral del plano.

